

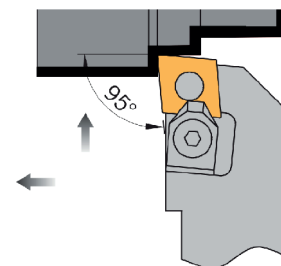

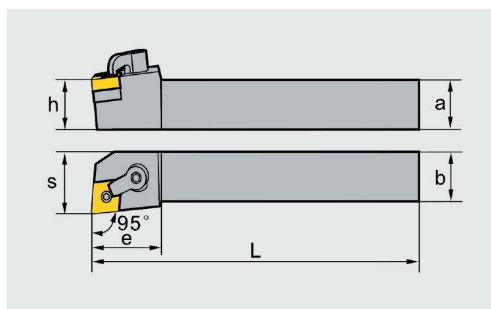



MCLNR/L

Кр: 95°



На снимке
изображено
правое
исполнение

Наименование державки	Размеры державки, мм						Тип сменной пластины	Винт	Тип подкл. пластины	Ключ	Прижим	Винт-штифт
	a	b	L	h	s	e						
MCLNR 2020 K12	20	20	125	20	25	32						
MCLNL 2020 K12	20	20	125	20	25	32	CN** 1204**	DM6X25	C12BM	WH30L	C1RD	TM6X17
MCLNR 2525 M12	25	25	150	25	32	32	CN** 1204**	DM6X30	C12BM	WH30L	C1RD	TM6X17
MCLNL 2525 M12	25	25	150	25	32	32	CN** 1204**	DM6X30	C12BM	WH30L	C1RD	TM6X17
MCLNR 3225 P12	32	25	170	32	32	32	CN** 1204**	DM6X30	C12BM	WH30L	C1RD	TM6X17
MCLNL 3225 P12	32	25	170	32	32	32	CN** 1204**	DM6X30	C12BM	WH30L	C1RD	TM6X17
MCLNR 2525 M16	25	25	150	25	32	38	CN** 1606**	DM6X30	C16BM	WH30L	C2RD	TM8X21
MCLNL 2525 M16	25	25	150	25	32	38	CN** 1606**	DM6X30	C16BM	WH30L	C2RD	TM8X21
MCLNR 3225 P16	32	25	170	25	32	38	CN** 1606**	DM6X30	C16BM	WH30L	C2RD	TM8X21
MCLNL 3225 P16	32	25	170	25	32	38	CN** 1606**	DM6X30	C16BM	WH30L	C2RD	TM8X21
MCLNR 3232 P16	32	32	170	32	40	38	CN** 1606**	DM6X30	C16BM	WH30L	C2RD	TM8X21
MCLNL 3232 P16	32	32	170	32	40	38	CN** 1606**	DM6X30	C16BM	WH30L	C2RD	TM8X21
MCLNR 3225 P19	32	25	170	32	40	45	CN** 1906**	DM8X30X	C19BM	WH40L	C5RD	TM10X21
MCLNL 3225 P19	32	25	170	32	40	45	CN** 1906**	DM8X30X	C19BM	WH40L	C5RD	TM10X21
MCLNR 3232 P19	32	32	170	32	40	45	CN** 1906**	DM8X30X	C19BM	WH40L	C5RD	TM10X21
MCLNL 3232 P19	32	32	170	32	40	45	CN** 1906**	DM8X30X	C19BM	WH40L	C5RD	TM10X21

Возможно применение пластин, соответствующих стандарту ISO, от любых производителей.